



Multicolor Scan Laser Photocoagulator

MC-500 Vixi

Multicolor Laser Photocoagulator

MC-500

US EDITION



THE ART OF EYE CARE



MC-500 *Vixi* / MC-500

The Versatile Laser Photocoagulator

The versatility of the MC-500 Vixi / MC-500 speaks for itself. The multiple functions of the MC-500 Vixi / MC-500 meet every requirement for laser photocoagulation.

Selectable configuration of laser colors and delivery units

Multiple scan patterns

Enhanced usability

The MC-500 Vixi / MC-500 provides various laser treatments including panretinal photocoagulation for diabetic retinopathy and laser iridotomy for glaucoma with a slit lamp delivery unit, retinal photocoagulation for retinopathy of prematurity with a BIO delivery unit, and endophotocoagulation via a probe.



Multicolor on Modular Architecture

Multicolor Laser for Multiple Applications

The MC-500 Vixi / MC-500 enables efficient photocoagulation even through opaque media. In cases of cataract, better penetration is achieved with the yellow (577 nm) laser compared to the green (532nm) laser.

In eyes with retinal hemorrhage, better penetration is achieved with the red (647 nm) laser.

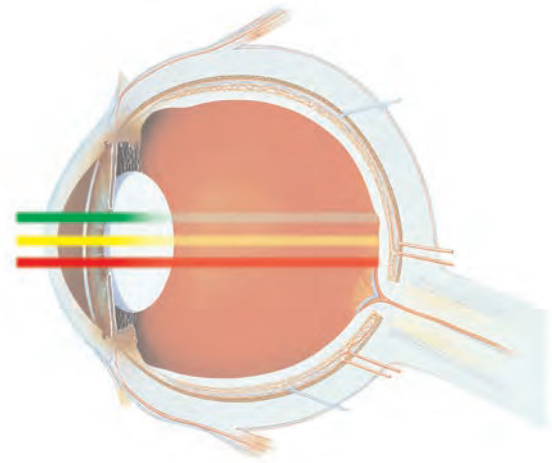

532 nm

The 532 nm (green) is the most common wavelength for treating retinal pathology.

577 nm

The 577 nm (yellow) laser is minimally absorbed by xanthophyll and is well absorbed by oxygenated hemoglobin compared to 561 nm and 568 nm lasers making it the wavelength of choice for lesions close to the macula. This wavelength has plentiful results achieved with the Dye lasers.

647 nm

The 647 nm (red) wavelength has been historically used in Krypton lasers. This wavelength is used for photocoagulation of deep choroidal pathology.

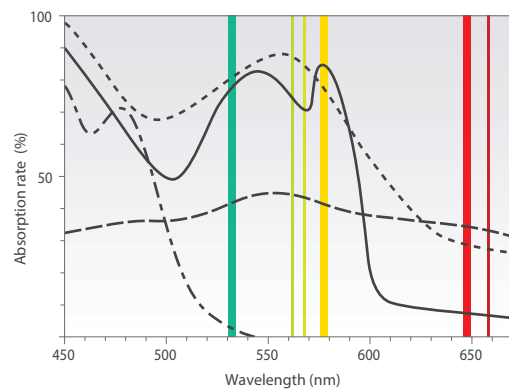

Reference: Folia Ophthalmol. Jpn. 40(5)1128-1133, 1989

- Pigment epithelium
- Reduced hemoglobin
- Oxygenated hemoglobin
- Xanthophyll
- 532 nm (MC-500, 300)
- 561 nm (MC-300)
- 577 nm (MC-500)
- 568 nm (MC-7000)
- 647 nm (MC-500, 7000)
- 659 nm (MC-300)

Selectable Laser Color Configuration

The MC-500 Vixi / MC-500, with its user friendly design, allows the selection of one, two, or three wavelengths, among green, yellow, and red. It enables the freedom to select the necessary color or combination of colors to increase efficiency of treatment.

Three-color selection	● Green ● Yellow ● Red		
Two-color selection	● Green ● Yellow	● Yellow ● Red	● Green ● Red
One-color selection	● Green	● Yellow	● Red

● Green ● Yellow ● Red

Multiple Scan Patterns

The MC-500 Vixi has 22 preprogrammed scan patterns to allow treatment of varying retinal pathologies.

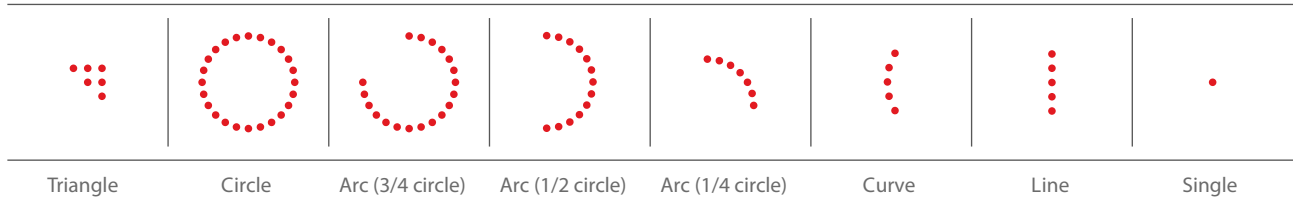
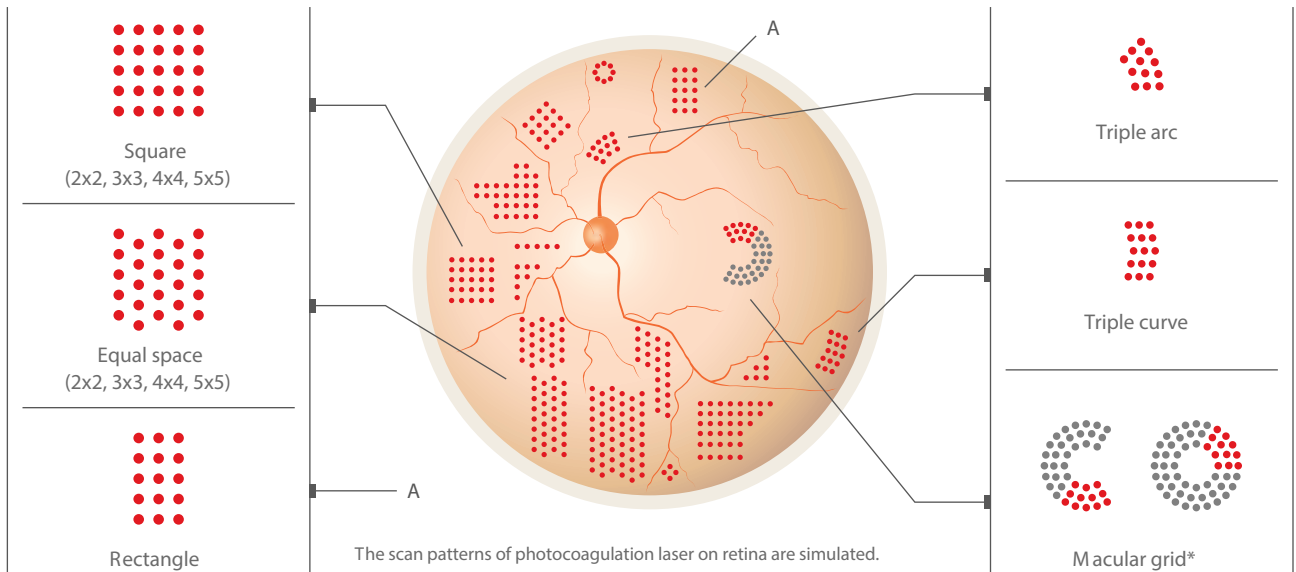

*The macular grid pattern is used for treatment of the periphery of macula in quadrants. The inner diameter is fixed and spot sizes range from 100 to 200 μm .

Typical Scan Patterns

Equal space
(2x2, 3x3, 4x4, 5x5)

The space between spots is equal in all directions.

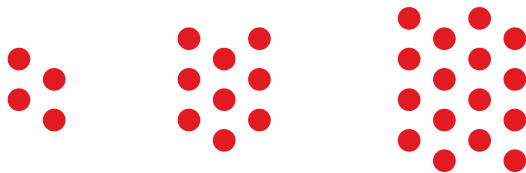

Square
(2x2, 3x3, 4x4, 5x5)

The space between spots is equal in the horizontal and vertical directions.

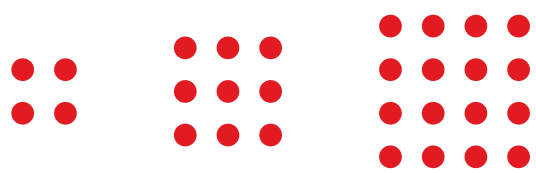

The square pattern makes larger spaces in the diagonal direction than the horizontal and vertical directions.

The equal space pattern keeps the spaces between spots equal allowing for denser photocoagulation than the square pattern.

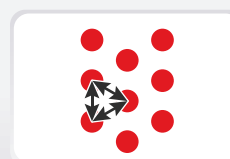

Equal space



Square

Auto Forward*

Once photocoagulation is completed in one region, the MC-500 Vixi allows automated positioning of the scan pattern to the next region to undergo photocoagulation. This feature allows the surgeon to concentrate on focus adjustment.

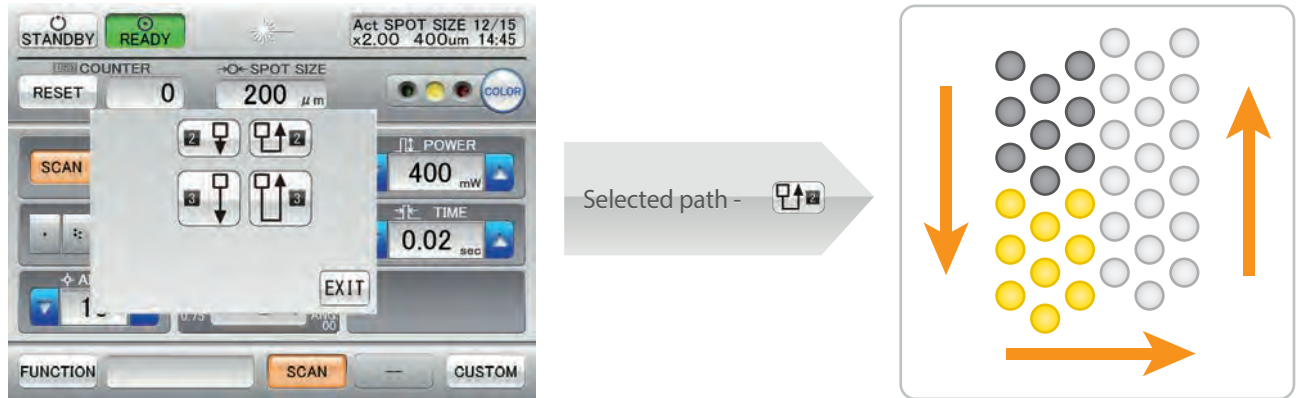

The repeat mode with the auto forward function enables consecutive regions to undergo photocoagulation on a selected path without repeatedly pressing the foot switch.

*The auto forward function is available for the equal space (2x2, 3x3, 4x4) and the square (2x2, 3x3, 4x4) patterns. The number of times of the forwarding differs depending on the scan pattern, spot size, and spacing.

Spot Spacing & Pattern Rotation

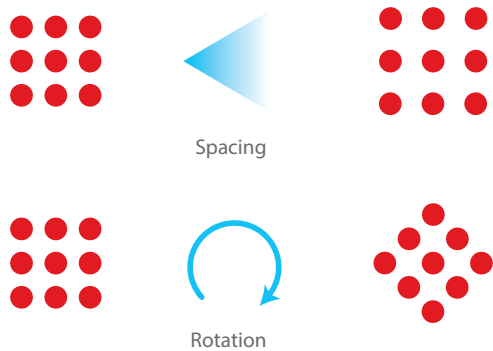

The space between spots in the pattern can be changed and the pattern can be rotated (15° increments) easily with the LCD touch screen.

Wide Range of Delivery Unit Options

In addition to conventional single delivery units the scan delivery units are added to the wide range of multicolor laser delivery systems. Both the scan and single delivery units include attachable models* for NIDEK SL-1800, ZEISS SL130 and 30SL/M, and HAAG 900BQ, which provide the existing slit lamps with a new stage for scan and single laser treatment.

*Prior confirmation of existing model's status is necessary for attachable models.

Scan Delivery Units (MC-500 Vixi)



Scan slit lamp delivery unit (NIDEK SL-1800)



Scan attachable delivery unit (NIDEK SL-1800, ZEISS SL130)



Scan attachable delivery unit (HAAG 900BQ)

Single Delivery Units (MC-500)



Slit lamp delivery unit (NIDEK SL-1800)



Attachable delivery unit (NIDEK SL-1800, ZEISS SL130)



BIO delivery unit (HEINE OMEGA 500)



YAG laser combination delivery unit (NIDEK YC-1800)

Dual Delivery Unit Connectors

The dual delivery unit connectors enable simultaneous connection with two delivery units, such as slit lamp delivery and BIO delivery units. They eliminate the inconvenience of connecting and disconnecting units and provide easy cable management.



Front Delivery Unit Connector (optional)

The combination of one delivery unit connector in front and one in back is available as a factory option. The front delivery unit connector helps with easy connecting and disconnecting.



SOLIC (Safety Optics with Low Impact on Cornea)

All scan slit lamp and slit lamp delivery units including attachable models incorporate the SOLIC optical design that ensures low energy density on the cornea and lens even for large spot sizes.

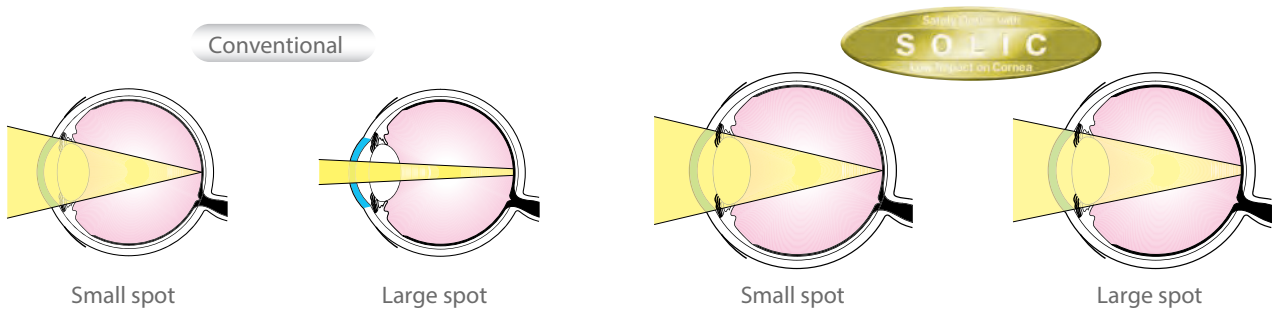

Continuously Variable Spot Size

The scan spot size is continuously variable from 100 to 500 μm (50 to 500 μm in single mode).

The continuous variability enables the surgeon to easily compensate for the spot size change due to the use of a laser contact lens.

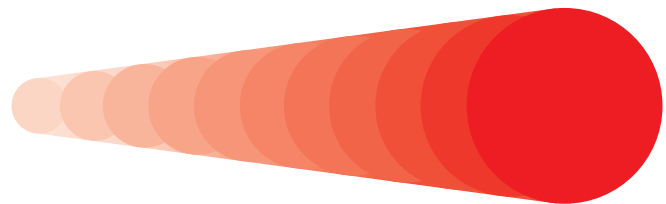

Stable Laser Power Output

Momentary increase followed by a plateau and an immediate decrease enables rapid and high-power laser emission on the scan patterns.

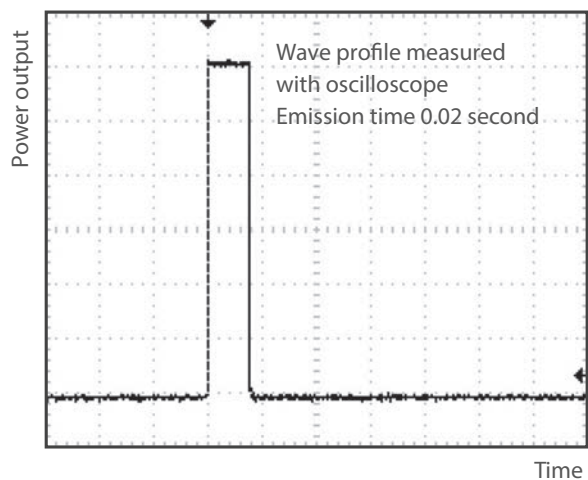

Practical and User-friendly Features

Intuitive graphic user interface and easy-to-read color LCD touch screen allows easy and quick setup and confirmation of the scan pattern and treatment parameters.

Pop-up Window

The pop-up window appears once the displayed value, such as POWER, TIME, and INTVL, is touched. It enables the surgeon to make significant changes to the laser values quickly with two-touch operations.

1. Touch the value on the screen
2. Select the value on the pop-up window

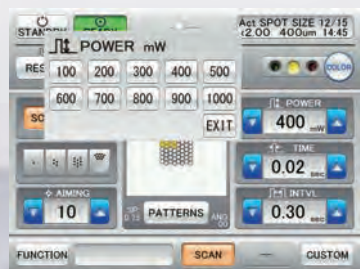

Spot Size

The spot size of the scan slit lamp delivery unit and slit lamp delivery unit is displayed on the LCD, and can be read with other parameters even in a dark room.

Actual Spot Size

The converted spot size is displayed once the laser spot magnification of laser contact lens is selected on the pop-up window.

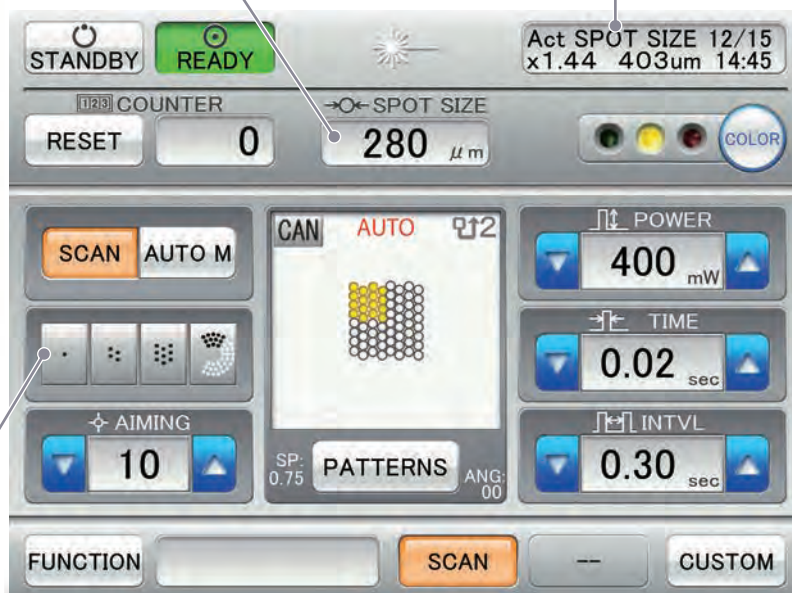

Memory of Scan Pattern*

Four frequently used scan patterns can be saved and recalled with one-touch selection.

*Available for the MC-500 Vixi

MC-500 Vixi LCD screen

This screen displays all buttons and items for convenience sake, but the actual screen is not consistent with this sample screen.

LCD Brightness Adjustment

When the status is switched from standby to ready the LCD brightness decreases so that there is no interference with the surgeon's visibility of ocular pathology during treatment.



STANDBY

READY

■ Multifunctional 3-D Mouse (optional)

The multifunctional 3-D mouse allows intuitive operation to change the parameters. Up to 10 parameters among 19 can be set with the multifunctional 3-D mouse.



■ Control Box (optional)

The power knob on the control box adopts a user-friendly dialing feature. Turning the knob enables change of the output power by 10 mW (up to 500 mW) or by 50 mW (higher than 500 mW). Turning and simultaneously depressing the knob enables to change by 100 mW.



■ Remote Control (optional)

The handheld remote control is useful to control output power and other parameters remotely. The phosphorescent panel provides visibility in the dark room during vitreoretinal surgery.



■ Memory of Photocoagulation Data

In accordance with various clinical cases up to 10 sets of photocoagulation data (color, power output, emission time, interval time, scan pattern, and spacing) can be registered. Each set is retrievable quickly with one-touch operation.

Memory No	Name	Color	Power mW	Time sec	Intvl sec	Ptn	SP
1	PRP Scan	G	300	0.020	0.00	3x3	0.75
2	PRP Scan	Y	300	0.020	0.00	3x3	0.75
3	PRP	G	200	0.200	0.40		
4	PRP	Y	150	0.200	0.40		
5	BRVO	G	200	0.200	0.00		
6	CRVO	R	200	0.200	0.00		
7	LI-1	G	200	0.200	0.00		
8	LI-2	G	1000	0.020	0.00		
9			000	0.000	0.00		
10			000	0.000	0.00		

Case of Panretinal Photocoagulation for Severe Non-Proliferative Diabetic Retinopathy

Total surgery time	24 minutes
Laser contact lens	Mainster PRP 165 (1.96x)
Wavelength (color)	577 nm (yellow)
Scan pattern	Square (2x2, 3x3, 4x4)
Spot size	200 μ m
Spacing	0.5, 0.75
Power output	300 - 450 mW
Emission time	0.02 second
Shots	4,772
Total energy	42.4 J

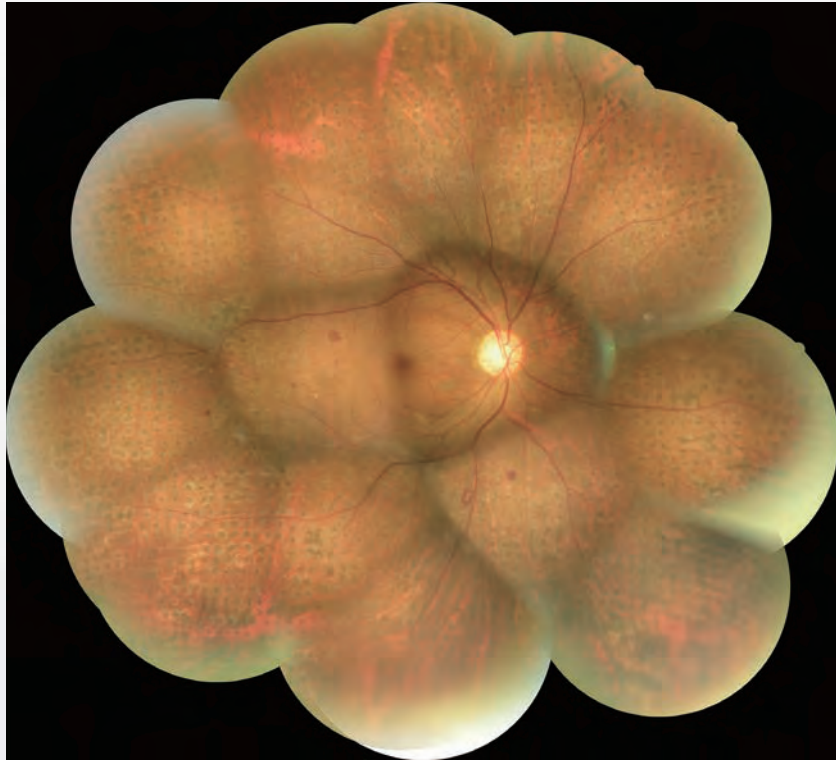

Color fundus image after photocoagulation

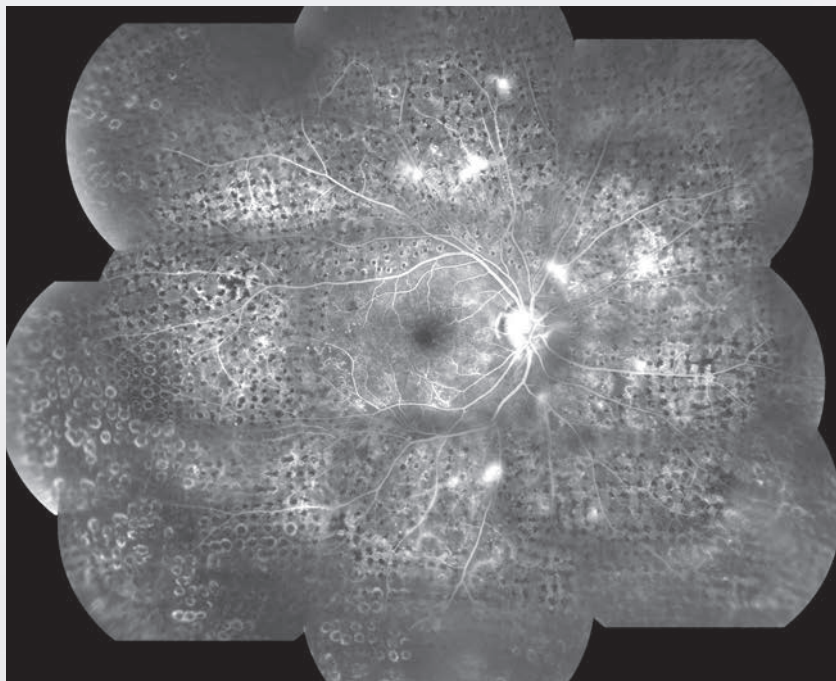

FA image after photocoagulation

Photo courtesy of Prof. Murata, Shinshu University

The case above is an excerpt from the case report of the multicolor laser photocoagulation with the MC-500 Vixi.

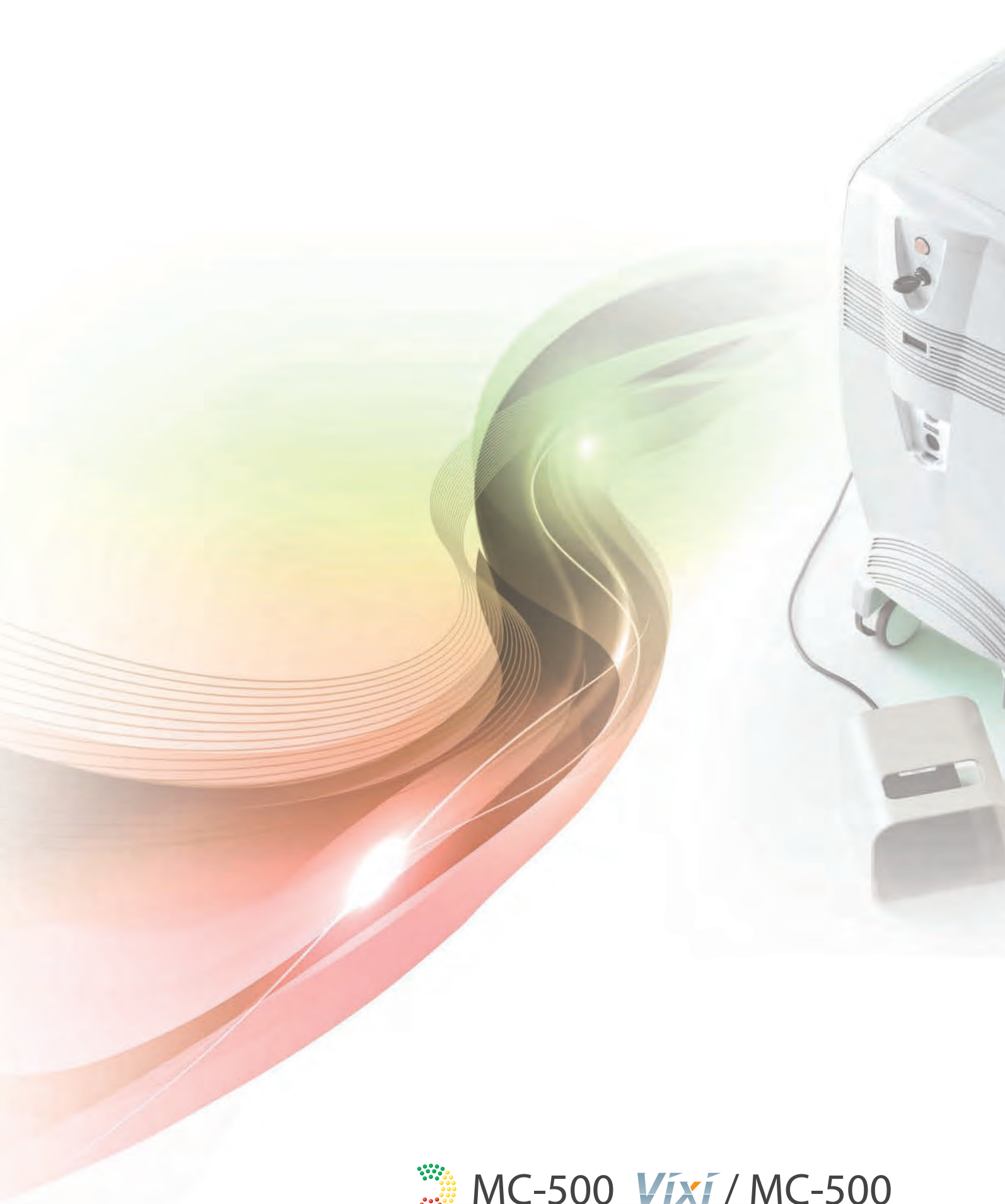

 MC-500 *Vixi* / MC-500

Main Body Specifications

Laser type	Solid state laser, Diode laser
Wavelength	Green : 532 nm Yellow : 577 nm Red : 647 nm
Power output	Green : 50 to 1700 mW *1 Yellow : 50 to 1500 mW Red : 50 to 800 mW *2
Output type	Continuous wave
Emission time	0.01 to 1.00 second, 2.00 seconds, 3.00 seconds *3
Interval time	0.05 to 1.0 second *4
Aiming laser	Red diode, 670 nm, max. 0.4 to 0.8 mW
Cooling system	Air-cooled
Power supply	AC 100 to 240 V, 50/60 Hz
Power consumption	400 VA
Dimensions / Mass	300 (W) x 480 (D) x 670 (H) mm / 35 kg 11.8 (W) x 18.9 (D) x 26.4 (H) " / 77.1 lbs.

*1 50 to 1500 mW with scan delivery unit

*2 With the slit lamp delivery unit, scan slit lamp delivery unit, attachable delivery unit, and scan attachable delivery unit, the maximum power output is limited according to the spot size.
Spot size 50 µm - 500 µm, Spot size 60 µm - 600 µm, Spot size 70 µm - 700 µm

*3 0.01 to 0.05 second in scan mode

*4 0.3 to 1.0 second in auto manipulation mode and auto forward function

Not available in scan mode except single scan pattern and other scan patterns available with auto forward function

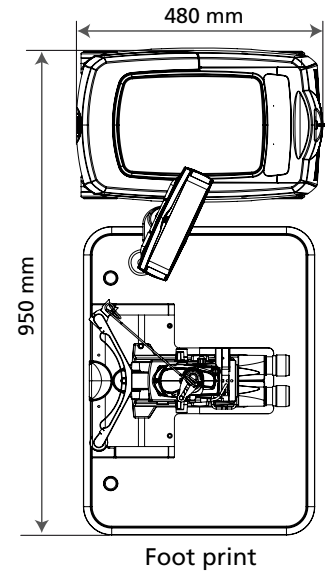

Scan / Single Delivery Unit Specifications

Model	Scan delivery unit (MC-500 Vixi)	Single delivery unit (MC-500)
Spot size	100 to 500 µm (scan mode & auto manipulation mode) 50 to 500 µm (single mode)	50 to 1000 µm (slit lamp & attachable deliveries)
Emission pattern	Single Square (2x2, 3x3, 4x4, 5x5), Equal space (2x2, 3x3, 4x4, 5x5), Rectangle, Triple arc, Triple curve, Macular grid, Triangle, Circle, Arc (3/4 circle, 1/2 circle, 1/4 circle), Curve, Line	Single
Type	Scan slit lamp delivery unit (NIDEK SL-1800) Scan attachable delivery unit (NIDEK SL-1800, ZEISS SL130 & 30SL/M, HAAG 900BQ)	Slit lamp delivery unit (NIDEK SL-1800) Attachable delivery unit (NIDEK SL-1800, ZEISS SL130 & 30SL/M) BIO delivery unit (HEINE OMEGA 500) YAG laser combination delivery unit (NIDEK YC-1800) Endophotocoagulation delivery unit (ZEISS, LEICA)
Dimensions / Mass	600 (W) x 450 (D) x 1300 to 1500 (H) mm / Approximately 45 kg *5 23.6 (W) x 17.7 (D) x 51.2 to 59.1 (H)" / Approximately 99.2 lbs. *5 (NIDEK SL-1800 scan slit lamp delivery with table)	← ← (NIDEK SL-1800 slit lamp delivery with table)

*5 The dimensions and mass differ depending on delivery types.



Product / Model name: Multicolor Laser Photocoagulator MC-500

Caution: U.S. Federal Law restricts this device to sale, distribution, and use by or on the order of a physician or other licensed eye care practitioner.

Specifications may vary depending on circumstances in each country.

Specifications and design are subject to change without notice.



NIDEK INC.
2040 Corporate Court
San Jose, CA 95131
Telephone: 1-800-223-9044 (US only)
URL: <http://usa.nidek.com>

HEAD OFFICE
34-14 Maehama, Hiroishi
Gamagori, Aichi 443-0038, Japan
Telephone: +81-533-67-6611
Facsimile: +81-533-67-6610
URL: <http://www.nidek.co.jp>
[Manufacturer]

TOKYO OFFICE
(International Div.)
3F Sumitomo Fudosan Hongo Bldg.,
3-22-5 Hongo, Bunkyo-ku, Tokyo
113-0033, Japan
Telephone: +81-3-5844-2641
Facsimile: +81-3-5844-2642
URL: <http://www.nidek.com>

NIDEK S.A.
Europarc
13, rue Auguste Perret
94042 Creteil, France
Telephone: +33-1-49 80 97 97
Facsimile: +33-149 80 32 08
URL: <http://www.nidek.fr>

NIDEK TECHNOLOGIES Srl
Via dell' Artigianato, 6/A
35020 Albignasego (Padova), Italy
Telephone: +39 049 8629200/8626399
Facsimile: +39 049 8626824
URL: <http://www.nidektechnologies.it>